 Prodotta da GRUPPO STAMPLAST
 è indicata in impianti di pulizia per
 piscine o di deflusso e raccolta di
 acque meteoriche.
 Materiale: Polipropilene
 Copolimero caricato con anti UV.

 CHANNEL DRAIN
 Manufactured by GRUPPO
 STAMPLAST it is indicated in
 cleaning systems for swimming
 pools and drainage of meteoric
 waters.
 Material: Stabilized Polypropylene
 Copolymer with anti UV.

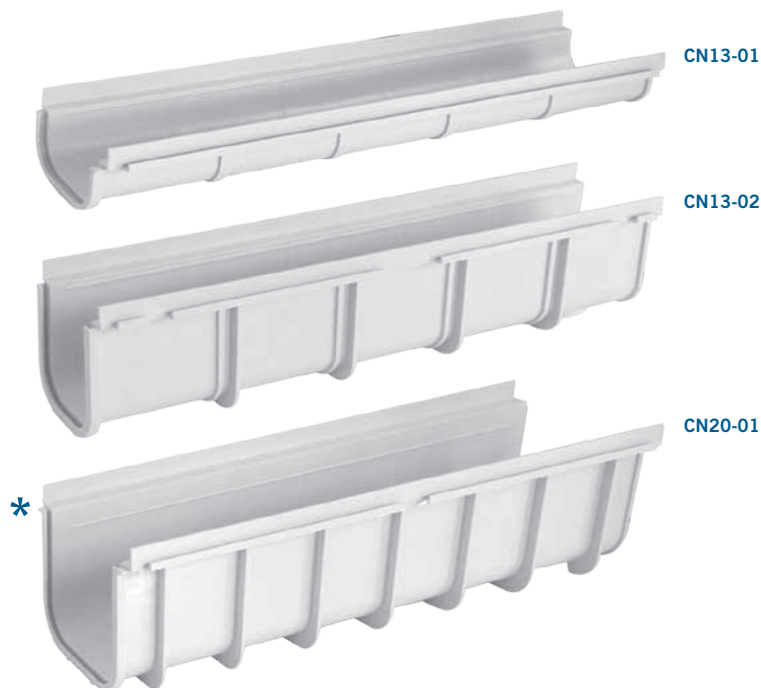







 CANIVEAU SEUL

 CANALETA



COLORI / COLORS

SCHEDA ORDINE PRODOTTO / PRODUCT ORDER DATA SHEET

COD.	MOD.*					
CN13-01	13xh7,5		20	640	100x120x225	0,420 kg/pz
CN13-02	13xh14		18	360	100x120x225	0,772 kg/pz
CN20-01	20xh16		10	200	100x120x225	0,905 kg/pz

*MEASURES IN CENTIMETERS

SCHEDA TECNICA PRODOTTO / TECHNICAL SHEET

MOD.*	A*	B*	D*	L*
13xh7,5	13	7,5	5	50
13xh14	13	14	5	50
20xh16	20	16	6 - 7,5 - 9	50

*MEASURES IN CENTIMETERS

 Scarichi inferiori canaletta
 H14: ø 50
 H16: ø 60-75-90

Base fissaggio griglia

